



Applications Note: AN_SY8009

High Efficiency 1.5MHz/1MHz, 1.5A/2A Synchronous Step Down Regulator *Preliminary Spec*

General Description

The SY8009A and SY8009B are high-efficiency, high frequency synchronous step-down DC-DC regulator ICs capable of delivering up to 1.5A/2A output currents. The SY8009 family operate over a wide input voltage range from 3V to 5.5V and integrate main switch and synchronous switch with very low $R_{DS(ON)}$ to minimize the conduction loss.

Low output voltage ripple and small external inductor and capacitor sizes are achieved with greater than 1MHz switching frequency.

Ordering Information

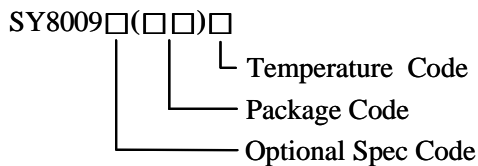

Temperature Range: -40°C to 85°C

Ordering Number	Package type	Note ^①
SY8009AAAC	SOT23-5	1.5A
SY8009BABC	SOT23-6	2A
SY8009BEBC	SSOT23-6	2A

Features

- Low $R_{DS(ON)}$ for internal switches (top/bottom)
 - SY8009A: 180mΩ/120mΩ, 1.5A, SOT23-5
 - SY8009B: 100mΩ/80mΩ, 2.0A, SOT23-6, SSOT23-6
- 3-5.5V input voltage range
- High switching frequency minimizes the external components
 - SY8009A: 1.5MHz
 - SY8009B: 1MHz
- Internal softstart limits the inrush current
- 100% dropout operation
- RoHS Compliant and Halogen Free
- Compact package: SOT23-5, SOT23-6 and Super SOT23-6 are pin-compatible. Other packages are available upon requests

Applications

- LCD TV
- Set Top Box
- Net PC
- Mini-Notebook PC
- Access Point Router

Typical Applications

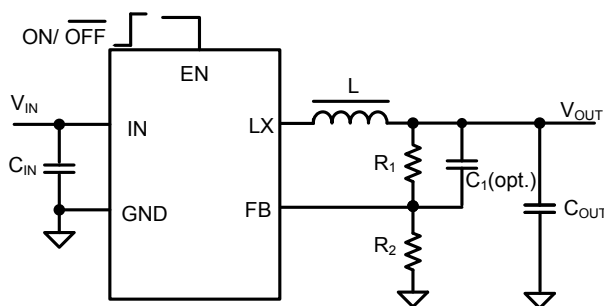

Figure 1. Schematic diagram

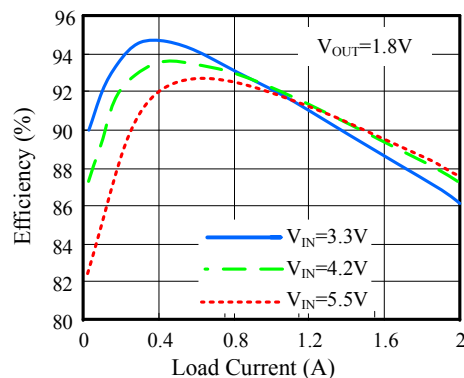
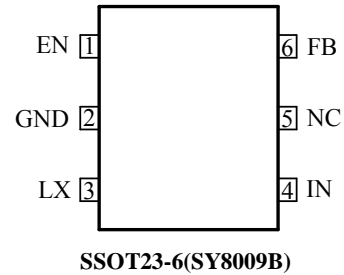
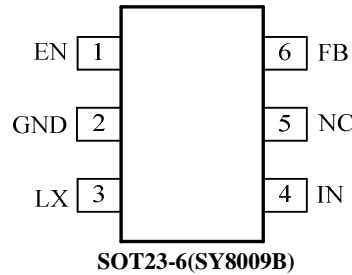
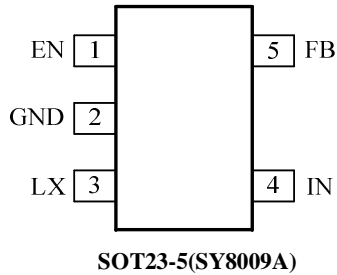

Figure 2. Efficiency vs Load Current



Pinout (top view)



Part Number	Package type	Top Mark ^①
SY8009AAAC	SOT23-5	ADxyz
SY8009BABC	SOT23-6	CUxyz
SY8009BEBC	SSOT23-6	ASxyz

Note ①: x=year code, y=week code, z= lot number code.

Pin Name	Pin Number	Pin Description
EN	1	Enable control. Pull high to turn on. Do not float.
GND	2	Ground pin
LX	3	Inductor pin. Connect this pin to the switching node of inductor.
IN	4	Input pin. Decouple this pin to GND pin with at least 1uF ceramic cap.
FB	6 (SY8009B)	Output Feedback Pin. Connect this pin to the center point of the output resistor divider (as shown in Figure 1) to program the output voltage: $V_{OUT}=0.6*(1+R_1/R_2)$.

Absolute Maximum Ratings (Note 1)

Supply Input Voltage	6.0V
Enable, FB Voltage	$V_{IN} + 0.6V$
Power Dissipation, P_D @ $T_A = 25^\circ C$,	
SOT23-5, SOT23-6	0.55W
SSOT23-6	0.6W
Package Thermal Resistance (Note 2)	
SOT23-5, SOT23-6, SSOT23-6, θ_{JA}	250°C/W
SOT23-5, SOT23-6, SSOT23-6, θ_{JC}	130°C/W
Junction Temperature Range	-150°C
Lead Temperature (Soldering, 10 sec.)	260°C
Storage Temperature Range	-65°C to 150°C
ESD Susceptibility (Note 2)	
HBM (Human Body Mode)	2kV
MM (Machine Mode)	200V
Dynamic LX voltage in 50ns duration	$IN+3V$ to $GND-4V$

Recommended Operating Conditions (Note 3)

Supply Input Voltage	-3V to 5.5V
Junction Temperature Range	-40°C to 125°C
Ambient Temperature Range	-40°C to 85°C



Electrical Characteristics

($V_{IN} = 5V$, $V_{OUT} = 2.5V$, $L = 2.2\mu H$, $C_{OUT} = 10\mu F$, $T_A = 25^\circ C$, unless otherwise specified)

Parameter	Symbol	Test Conditions	Min	Typ	Max	Unit
Input Voltage Range	V_{IN}		3		5.5	V
Quiescent Current	I_Q	$I_{OUT}=0$, $V_{FB}=V_{REF} \cdot 105\%$		80		μA
Shutdown Current	I_{SHDN}	EN=0		0.1	1	μA
Feedback Reference Voltage	V_{REF}		0.588	0.6	0.612	V
FB Input Current	I_{FB}	$V_{FB}=V_{IN}$	-50		50	nA
PFET RON	$R_{DS(ON),P}$	SY8009A		180		$m\Omega$
		SY8009B		100		$m\Omega$
NFET RON	$R_{DS(ON),N}$	SY8009A		120		$m\Omega$
		SY8009B		80		$m\Omega$
PFET Current Limit	I_{LIM}	SY8009A	1.8			A
		SY8009B	2.5			A
EN Rising Threshold	V_{ENH}		1.5			V
EN Falling Threshold	V_{ENL}				0.4	V
Input UVLO Threshold	V_{UVLO}				2.7	V
UVLO Hysteresis	V_{HYS}			0.1		V
Oscillator Frequency	F_{OSC}	$I_{OUT}=200mA$, SY8009A		1.5		MHz
		$I_{OUT}=500mA$, SY8009B		1		MHz
Min ON Time				50		ns
Max Duty Cycle			100			%
Thermal Shutdown Temperature	T_{SD}			160		$^\circ C$

Note 1: Stresses listed as the above “Absolute Maximum Ratings” may cause permanent damage to the device. These are for stress ratings. Functional operation of the device at these or any other conditions beyond those indicated in the operational sections of the specifications is not implied. Exposure to absolute maximum rating conditions for extended periods may remain possibility to affect device reliability.

Note 2: θ_{JA} is measured in the natural convection at $T_A = 25^\circ C$ on a low effective single layer thermal conductivity test board of JEDEC 51-3 thermal measurement standard. Pin 2 of SOT23-5/SOT23-6/SSOT23-5 packages is the case position for θ_{JC} measurement.

Note 3: The device is not guaranteed to function outside its operating conditions.

Typical Performance Characteristics (SY8009B)

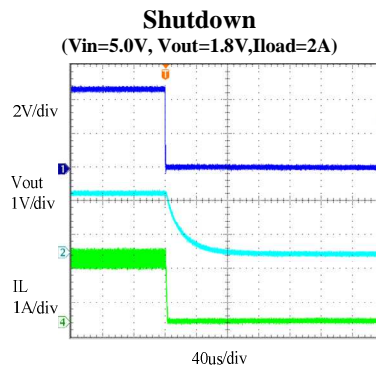
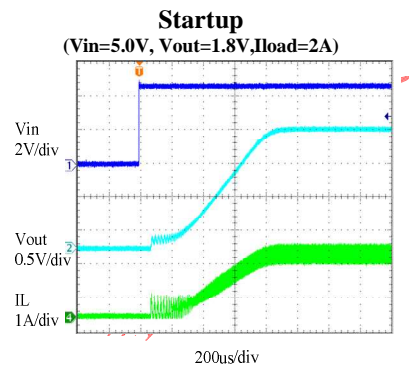
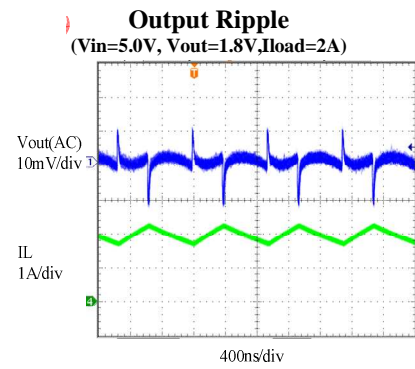
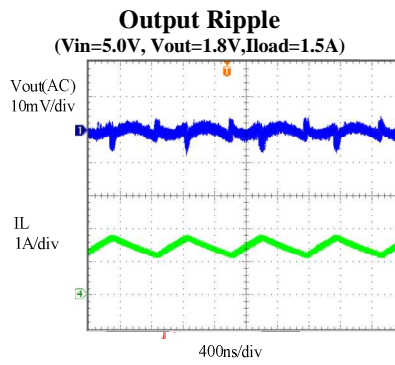
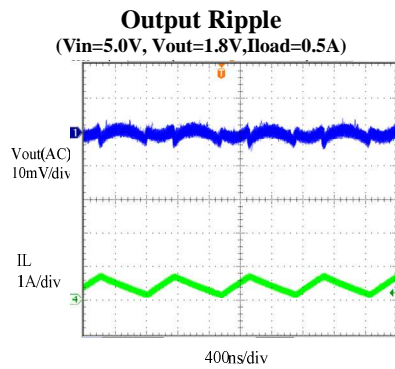
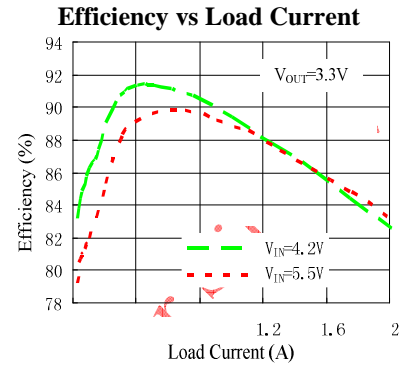
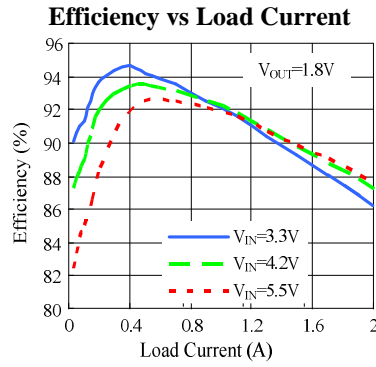
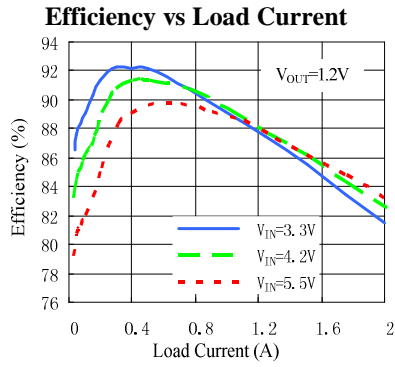



Soft Start(Vo)

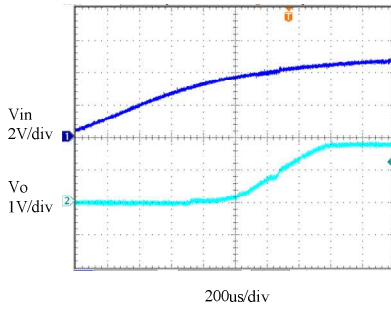

Soft Start(Lx)

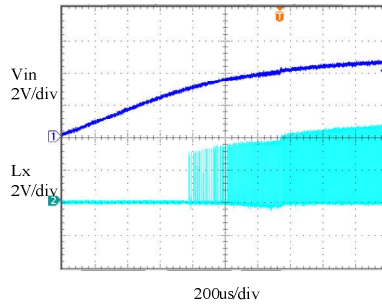

Load Transient
(Vin=5.0V, Vout=1.8V, Iload=0-1A)

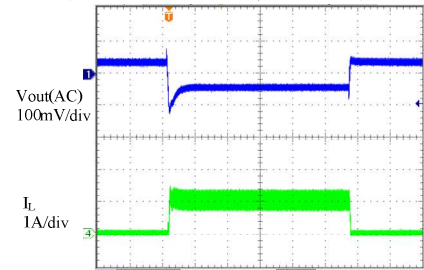

Load Transient
(Vin=5.0V, Vout=1.8V, Iload=0.2~2A)

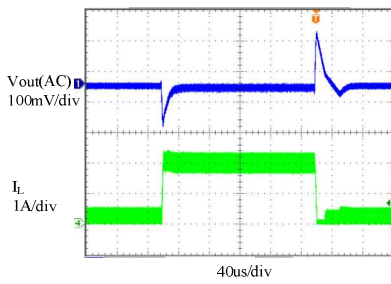

Oscillator Frequency vs Vin

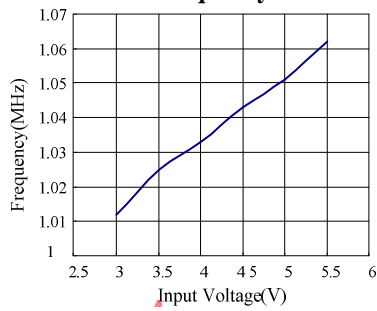

Case Temperature vs Output Current

(Vin=5V, Vo=1.8V, Ta=27°C)

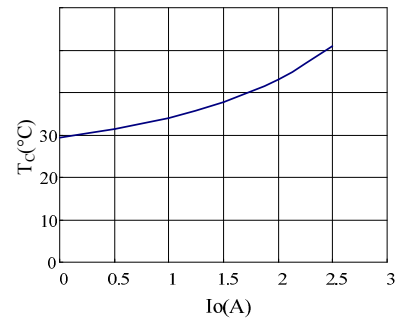



Operation

SY8009 is a synchronous buck regulator IC that integrates the PWM control, top and bottom switches on the same die to minimize the switching transition loss and conduction loss. With ultra low $R_{DS(ON)}$ power switches and proprietary PWM control, this regulator IC can achieve the highest efficiency and the highest switch frequency simultaneously to minimize the external inductor and capacitor size, and thus achieving the minimum solution footprint.

Applications Information

Because of the high integration in the SY8009 IC, the application circuit based on this regulator IC is rather simple. Only input capacitor C_{IN} , output capacitor C_{OUT} , output inductor L and feedback resistors (R1 and R2) need to be selected for the targeted applications specifications.

Feedback resistor dividers R1 and R2:

Choose R1 and R2 to program the proper output voltage. To minimize the power consumption under light loads, it is desirable to choose large resistance values for both R1 and R2. A value of between 10k and 200k is highly recommended for R2. If R2=100k is chosen, then R1 can be calculated to be:

$$R_1 = \frac{(V_{OUT} - 0.6V) \cdot R_2}{0.6V}$$

Input capacitor C_{IN} :

With the maximum load current at 1.2A, the maximum ripple current through input capacitor is about 0.6Arms. A typical X7R or better grade ceramic capacitor with 6V rating and greater than 4.7uF capacitance can handle this ripple current well. To minimize the potential noise problem, place this ceramic capacitor really close to the IN and GND pins. Care should be taken to minimize the loop area formed by C_{IN} , and IN/GND pins.

Output capacitor C_{OUT} :

The output capacitor is selected to handle the output ripple noise requirements. Both steady state ripple and transient requirements must be taken into consideration when selecting this capacitor. For the best performance, it is recommended to use X7R or better grade ceramic capacitor with 6V rating and greater than 4.7uF capacitance.

Output inductor L:

There are several considerations in choosing this inductor.

- 1) Choose the inductance to provide the desired ripple current. It is suggested to choose the ripple current to be about 40% of the maximum output current. The inductance is calculated as:

$$L = \frac{V_{OUT}(1 - V_{OUT}/V_{IN,MAX})}{F_{SW} \times I_{OUT,MAX} \times 40\%}$$

where F_{sw} is the switching frequency and $I_{OUT,MAX}$ is the maximum load current.

The SY8009 regulator IC is quite tolerant of different ripple current amplitude. Consequently, the final choice of inductance can be slightly off the calculation value without significantly impacting the performance.

- 2) The saturation current rating of the inductor must be selected to be greater than the peak inductor current under full load conditions.

$$I_{SAT, MIN} > I_{OUT, MAX} + \frac{V_{OUT}(1 - V_{OUT}/V_{IN,MAX})}{2 \cdot F_{SW} \cdot L}$$

- 3) The DCR of the inductor and the core loss at the switching frequency must be low enough to achieve the desired efficiency requirement. It is desirable to choose an inductor with $DCR < 50m\Omega$ to achieve a good overall efficiency.

Layout Design:

The layout design of SY8009 regulator is relatively simple. For the best efficiency and minimum noise problems, we should place the following components close to the IC: C_{IN} , L, R1 and R2.

- 1) It is desirable to maximize the PCB copper area connecting to GND pin to achieve the best thermal and noise performance. If the board space allowed, a ground plane is highly desirable.



- 2) C_{IN} must be close to Pins IN and GND. The loop area formed by C_{IN} and GND must be minimized.
- 3) The PCB copper area associated with LX pin must be minimized to avoid the potential noise problem.
- 4) The components R1 and R2, and the trace connecting to the FB pin must NOT be adjacent to the LX net on the PCB layout to avoid the noise problem.
- 5) If the system chip interfacing with the EN pin has a high impedance state at shutdown mode and the IN pin is connected directly to a power source such as a LiIon battery, it is desirable to add a pull down $1M\Omega$ resistor between the EN and GND pins to prevent the noise from falsely turning on the regulator at shutdown mode.

Load Transient Considerations:

The SY8009 regulator IC integrates the compensation components to achieve good stability and fast transient responses. In some applications, adding a 22pF ceramic cap in parallel with R1 may further speed up the load transient responses and is thus recommended for applications with large load transient step requirements.

SOT23-5 Package outline & PCB layout design

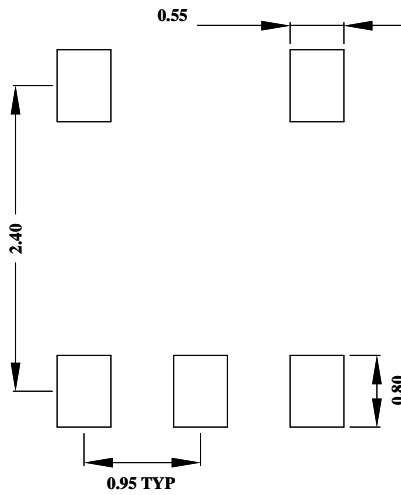

Recommended Pad Layout

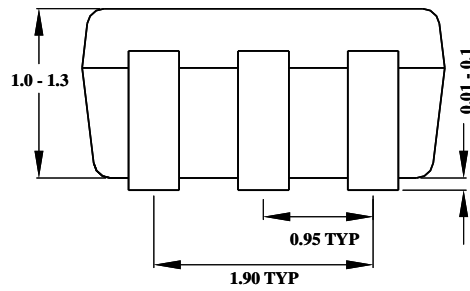
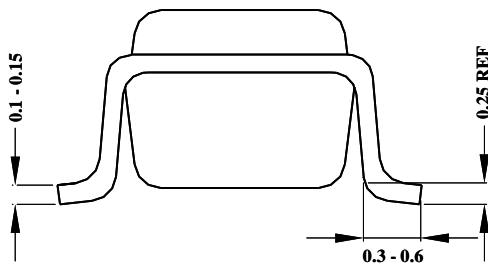
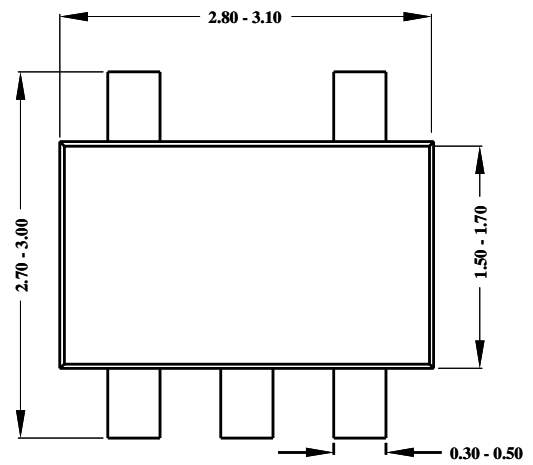

**Notes: All dimensions are in millimeters.
All dimensions don't include mold flash & metal burr.**

SSOT23-6 Package outline & PCB layout design

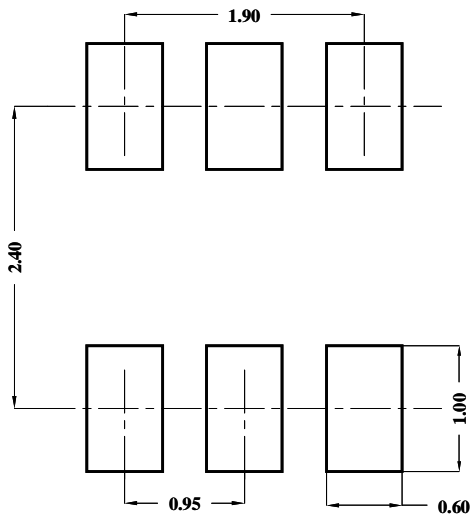

Recommended Pad Layout

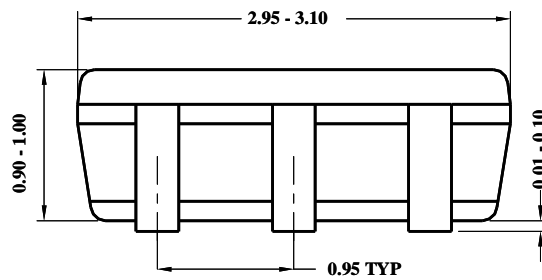
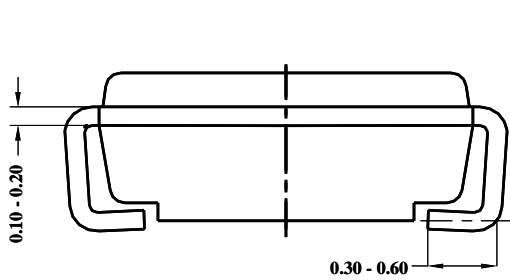
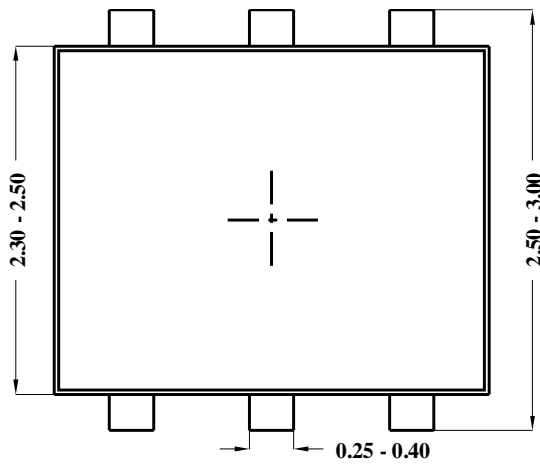

**Notes: All dimensions are in millimeters.
All dimensions don't include mold flash & metal burr.**